

TYP 201

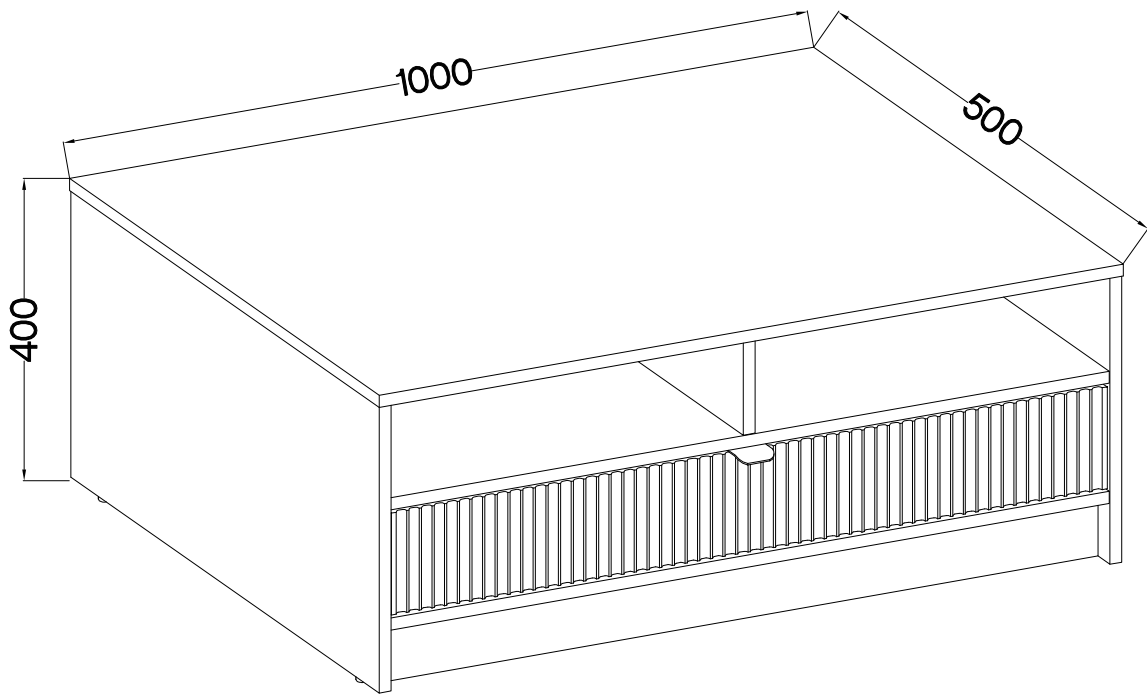

 †8x30mm <b>A</b> 28	 †6x42mm <b>B2</b> 2	 †15/12mm <b>C</b> 22	 †12/10mm <b>C5</b> 2	 L=20mm <b>D2</b> 24	 <b>E</b> 8				
 †15x5mm <b>F4</b> 6	 27/310mm <b>I4</b> 1	 L=450 mm <b>K34</b> 1	 <b>L</b> 4	 †6,3x13mm <b>M2</b> 4	 †4.0x16mm <b>P1</b> 4	 †3.5x13mm <b>P5</b> 2	 L=32mm <b>S</b> 1	 <b>T3</b> 2	 M4x9mm <b>U1</b> 2

ISM-TNO-006

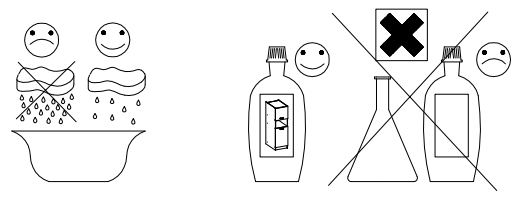
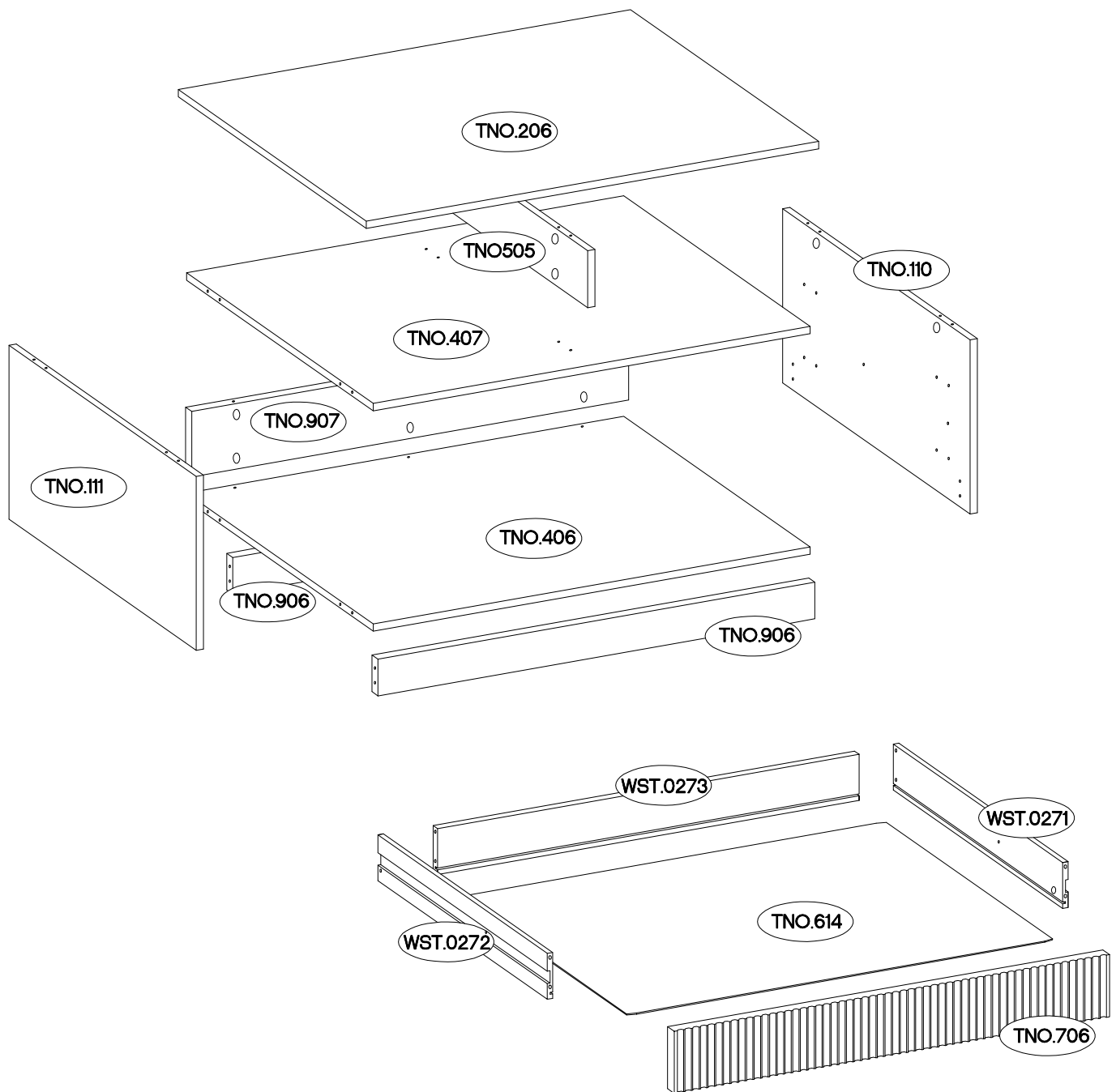

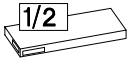
	Ersatzteil Nummer	Dimension
	TNO.110	379x498x16
	TNO.111	379x498x16
	TNO.505	124x494x16
	TNO.206	1000x500x16
	TNO.406	966x496x16
	TNO.407	966x496x16
	TNO.906 x2	966x80x16
	TNO.907	966x143x16
	TNO.614	943x447x2,5
	WST.0271	450x100x12
	WST.0272	450x100x12
	WST.0273	932x100x12
	TNO.706	135x962x18



TMR.206





TMR.407



TNO.614

1

 <b>C5</b> 2	 <b>A</b> 4
--	---

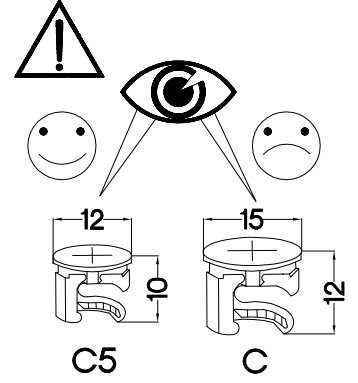
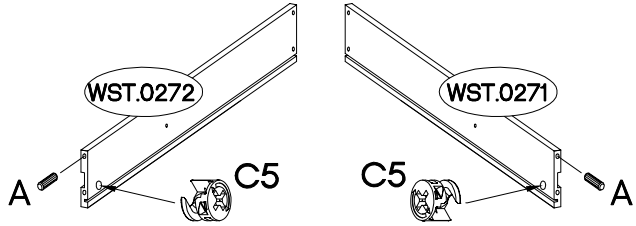
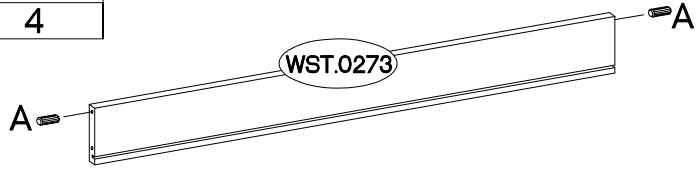
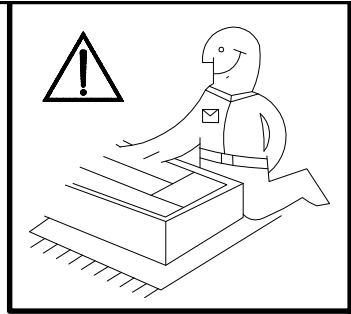

2

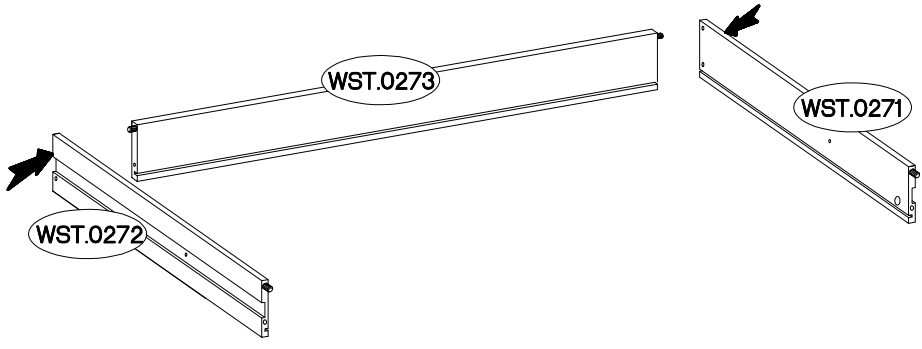

 <b>B2</b> 2
---

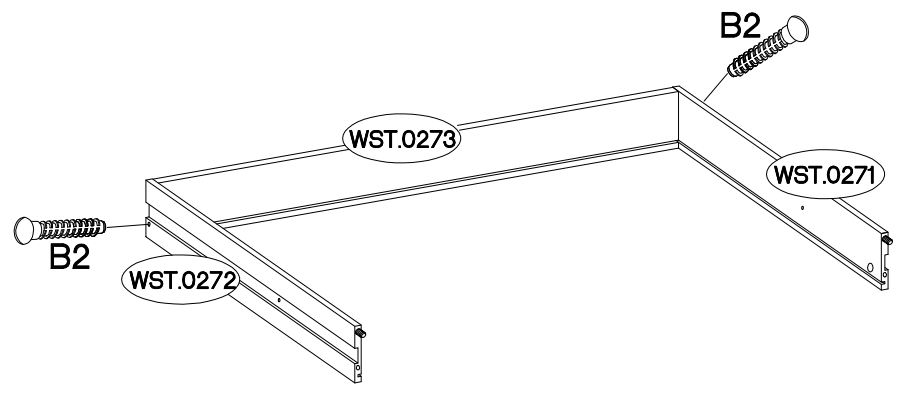
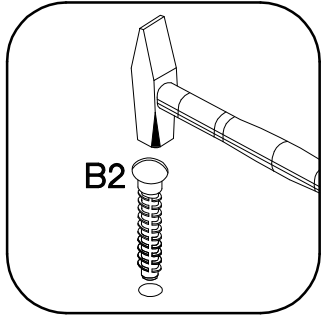

3

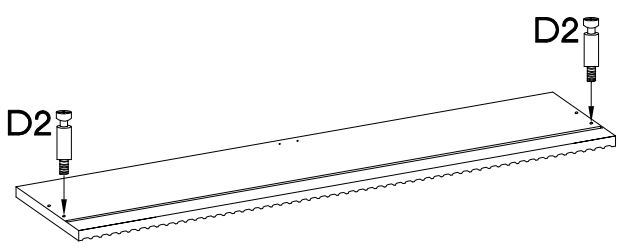
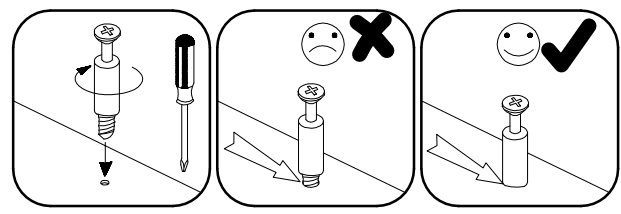

 <b>D2</b> 2
--



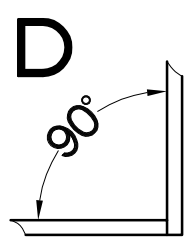
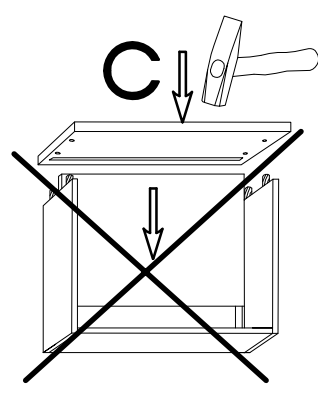
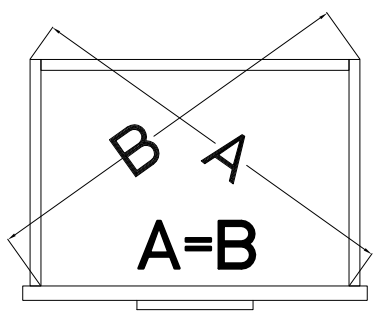
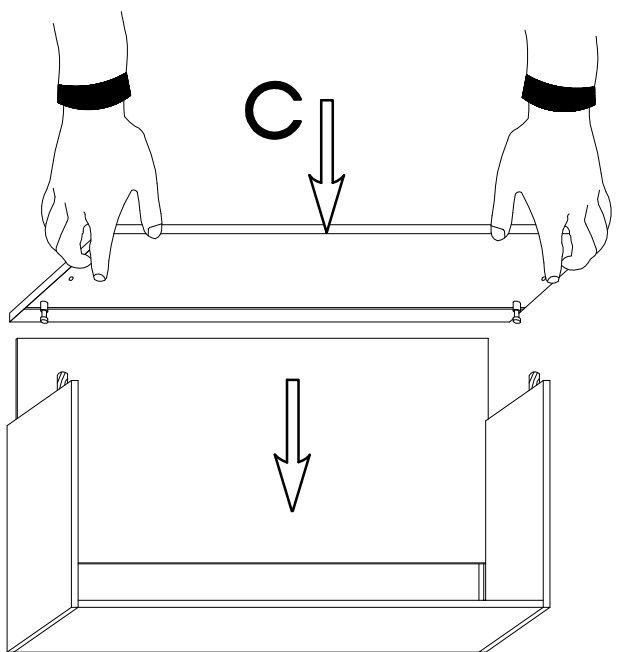
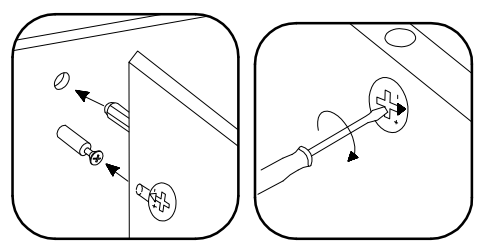
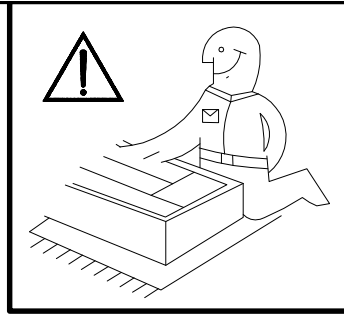
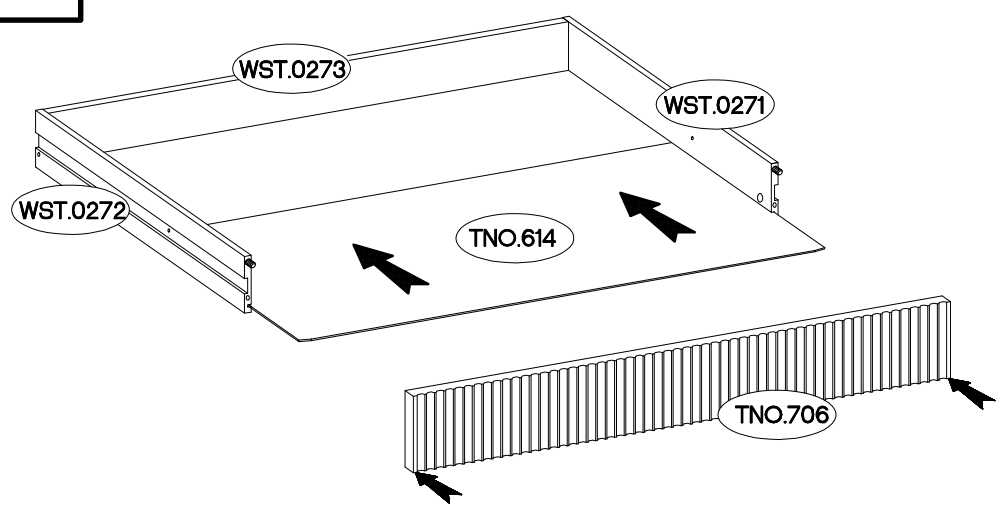



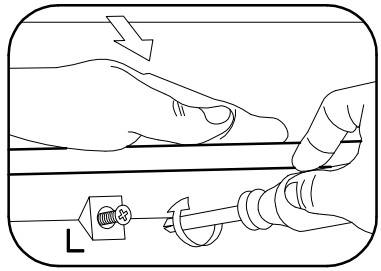
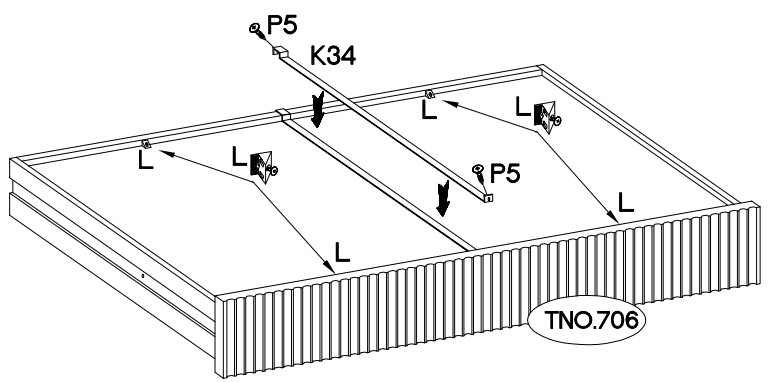
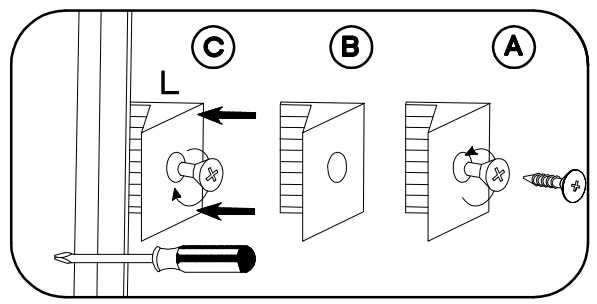

4



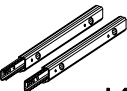

5

	L-450 mm 	$\pm 3.5 \times 13 \text{ mm}$ 
L 4	K34 1	P5 2

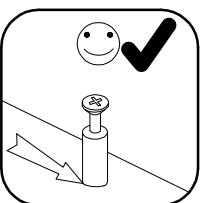
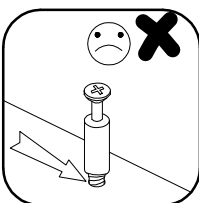
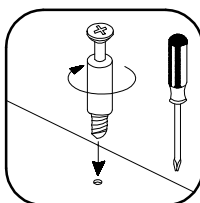
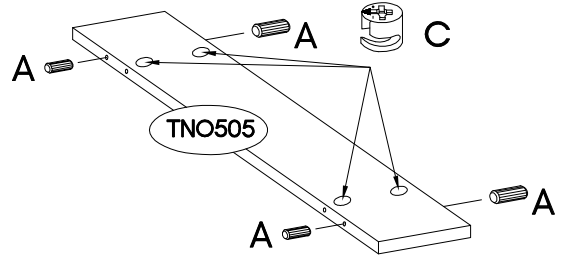
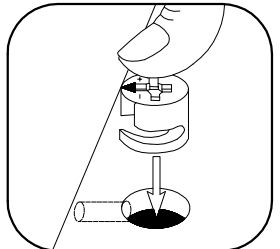
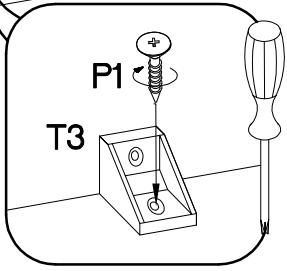
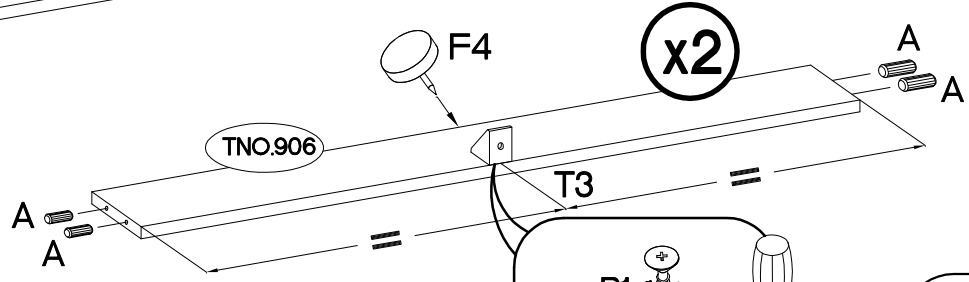
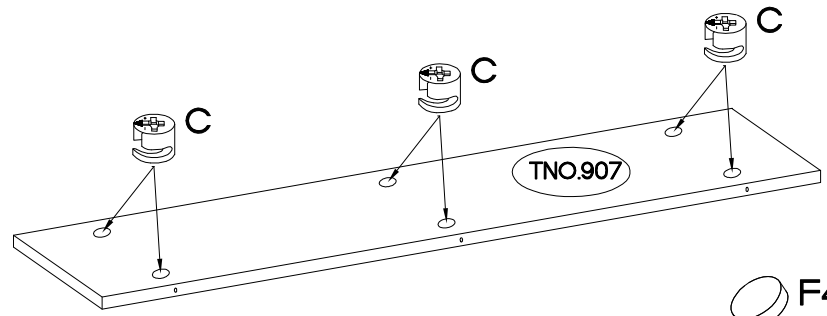
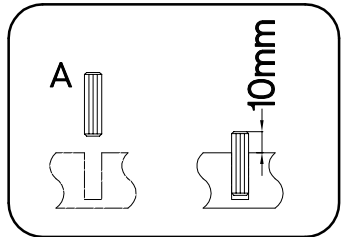
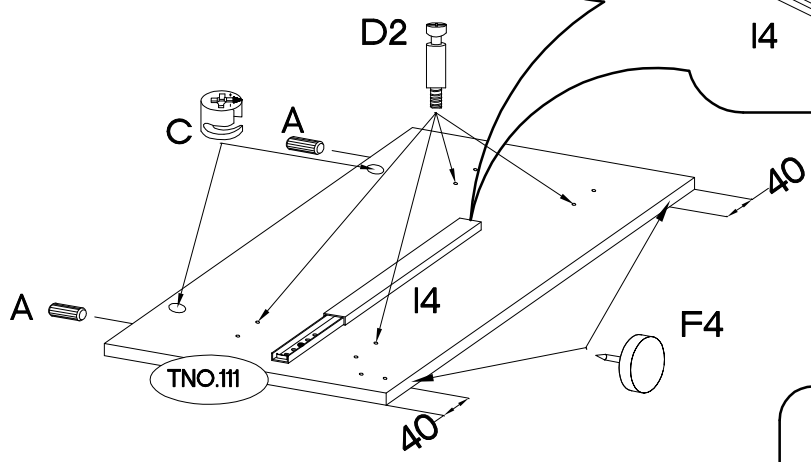
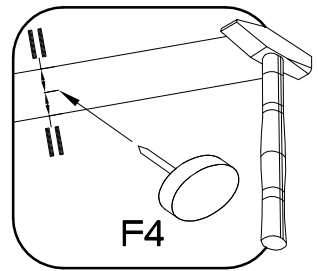
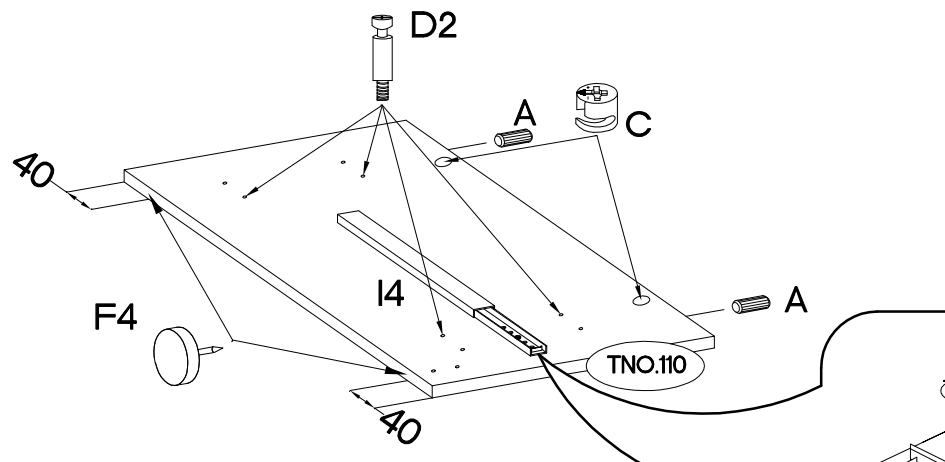
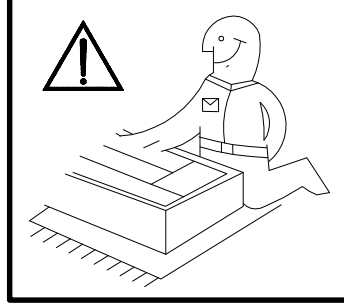

±8x30mm	±15/12mm	L=20mm	±15x5mm	27/310mm	±6,3x13mm		±4.0x16mm
							
A	C	D2	F4	I4	M2	T3	P1
16	14	8	6	1	4	2	2

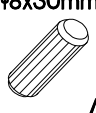
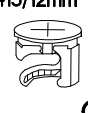

$\varnothing 8 \times 30 \text{mm}$	$\varnothing 15/12 \text{mm}$	L=20mm
		
A	C	D2
8	8	14

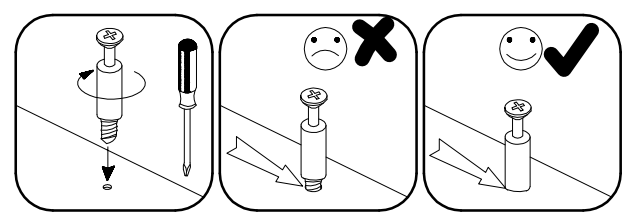
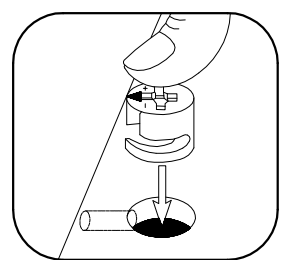
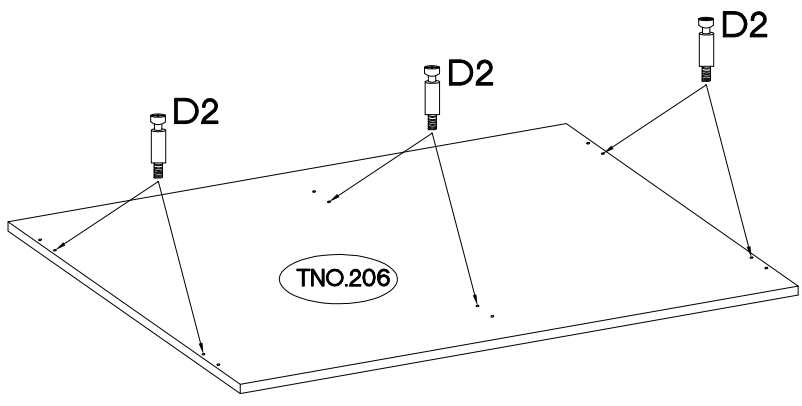
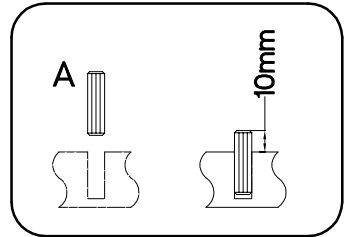
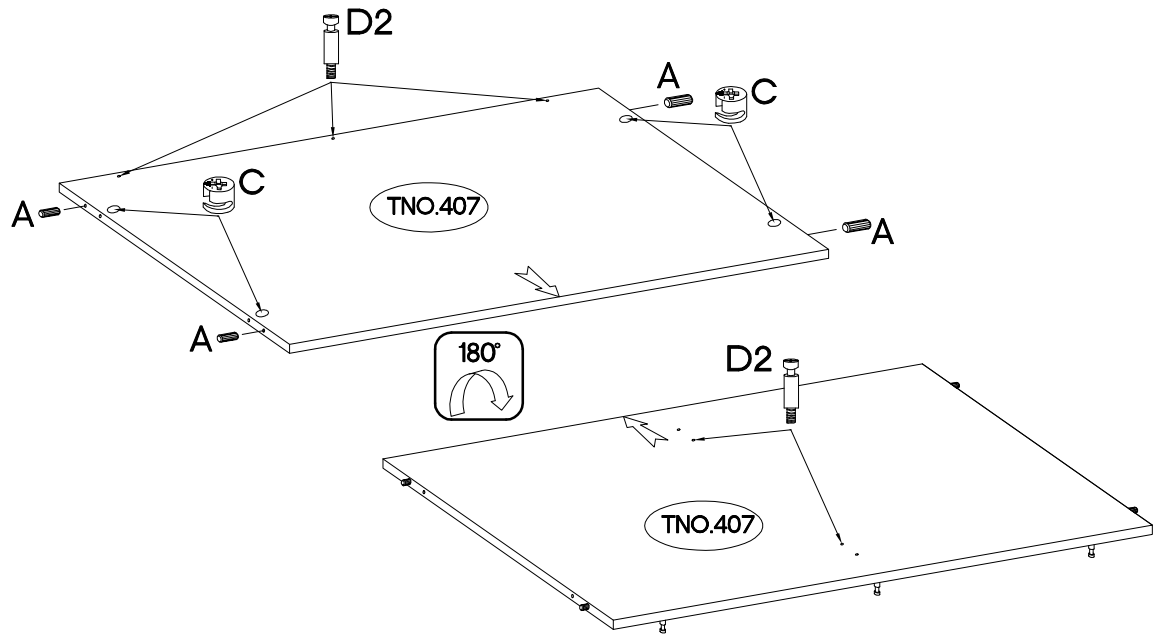
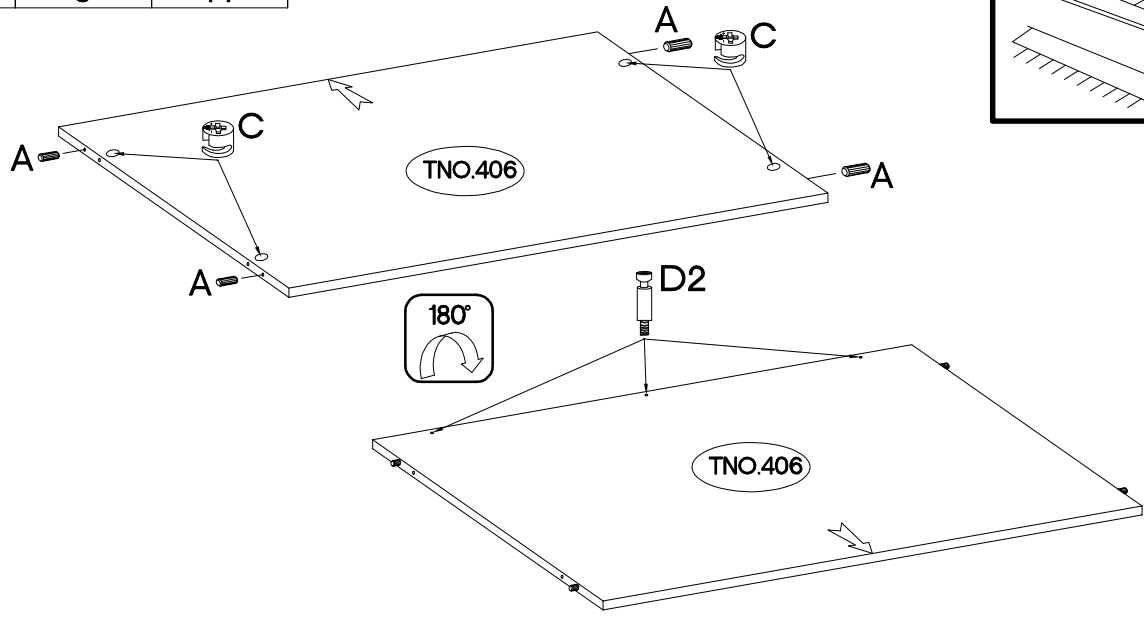
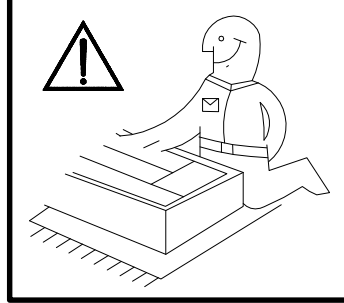

8

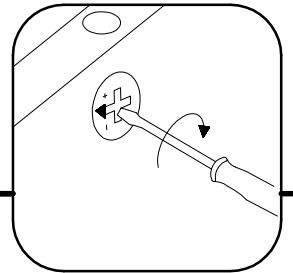
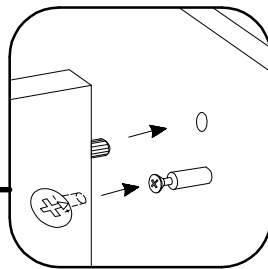
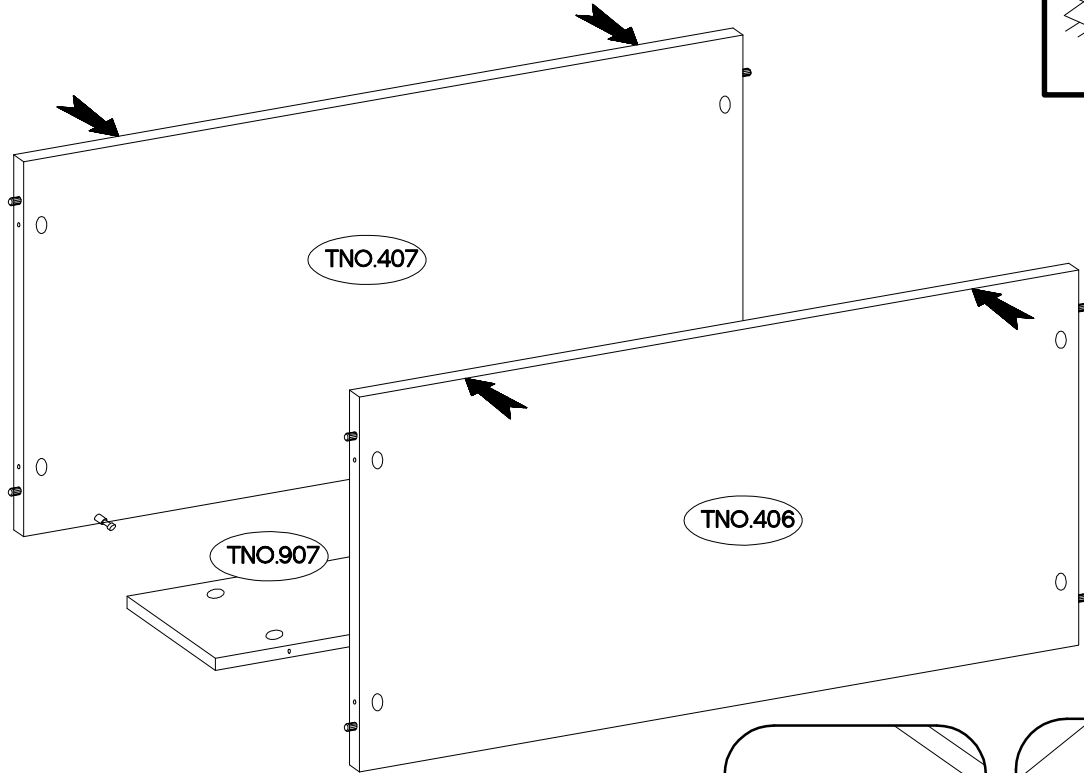
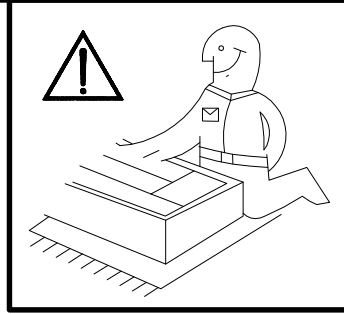

9

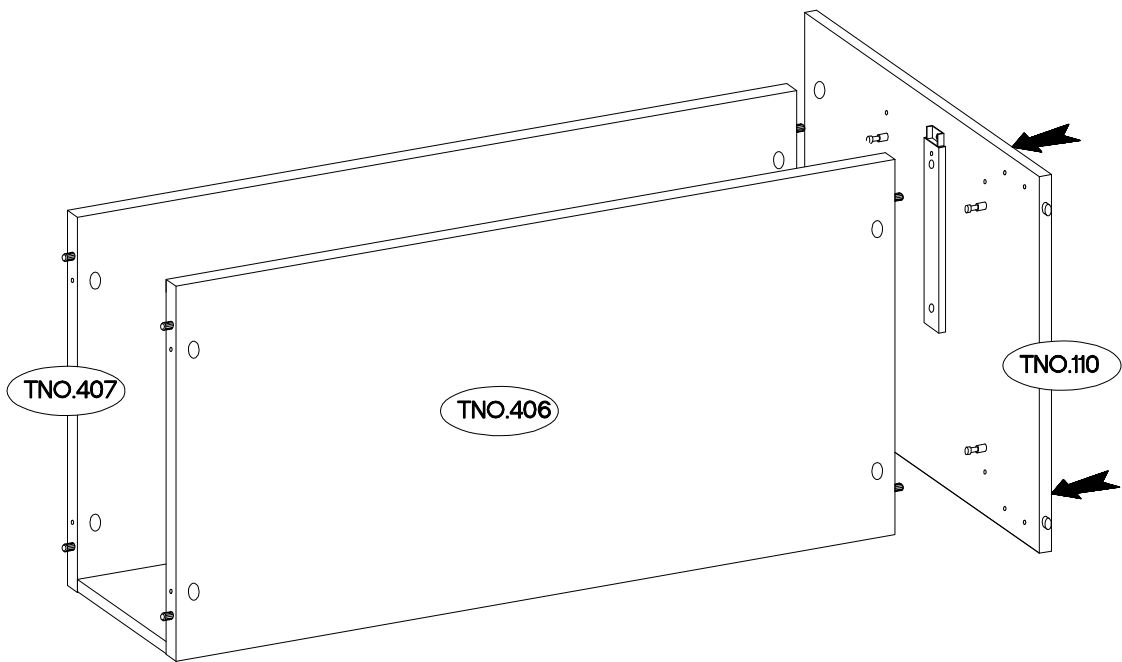

10

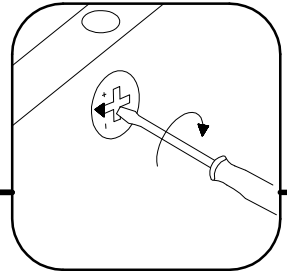
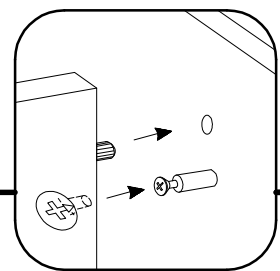
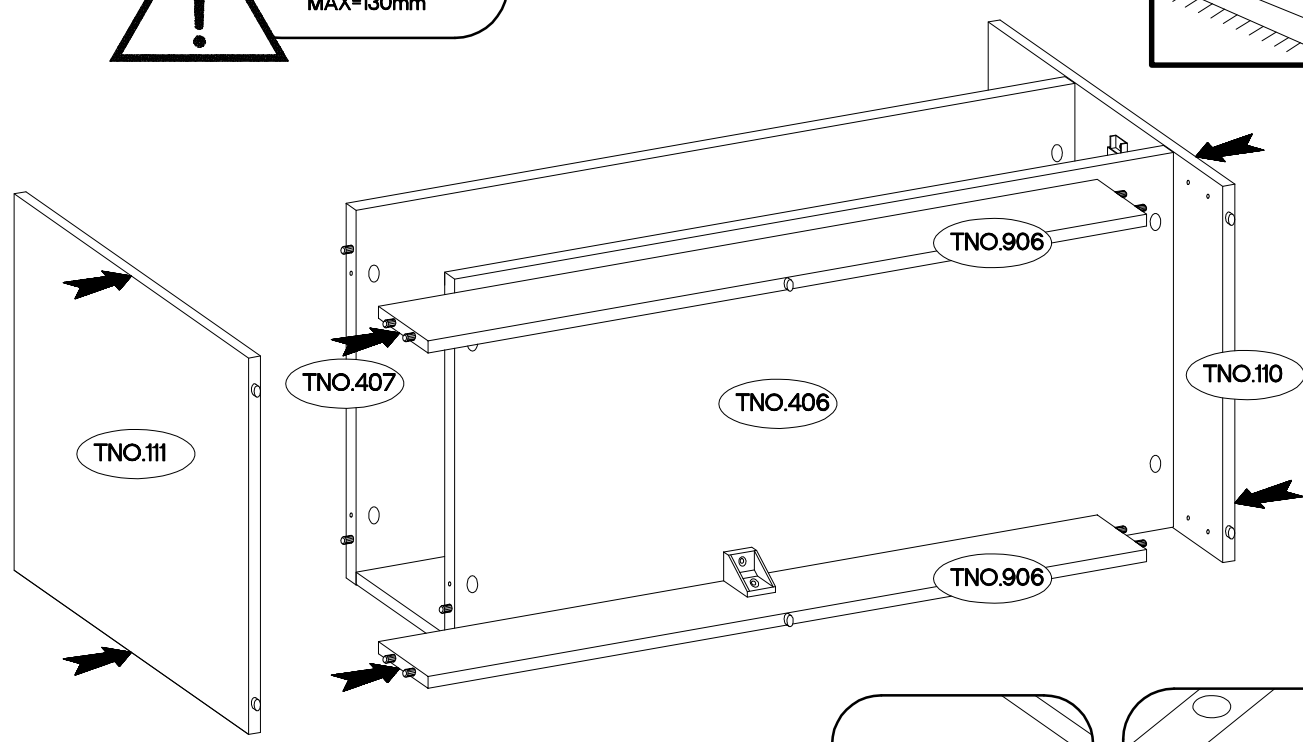
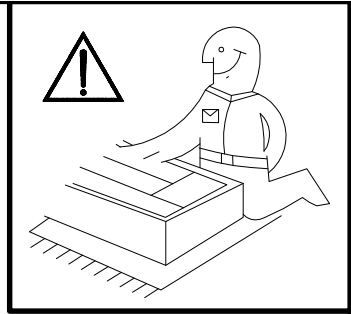
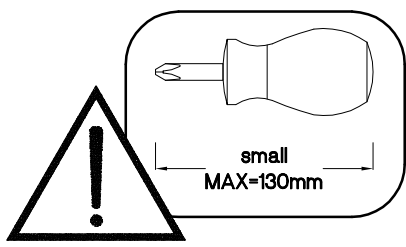

11

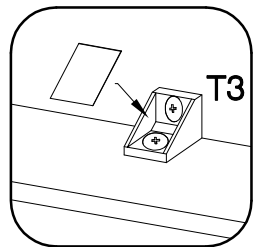
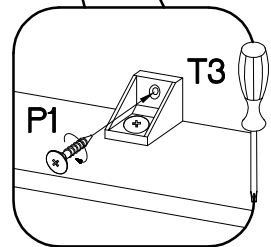
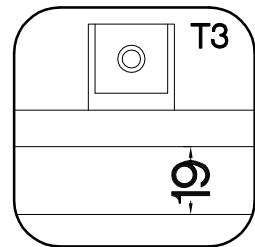
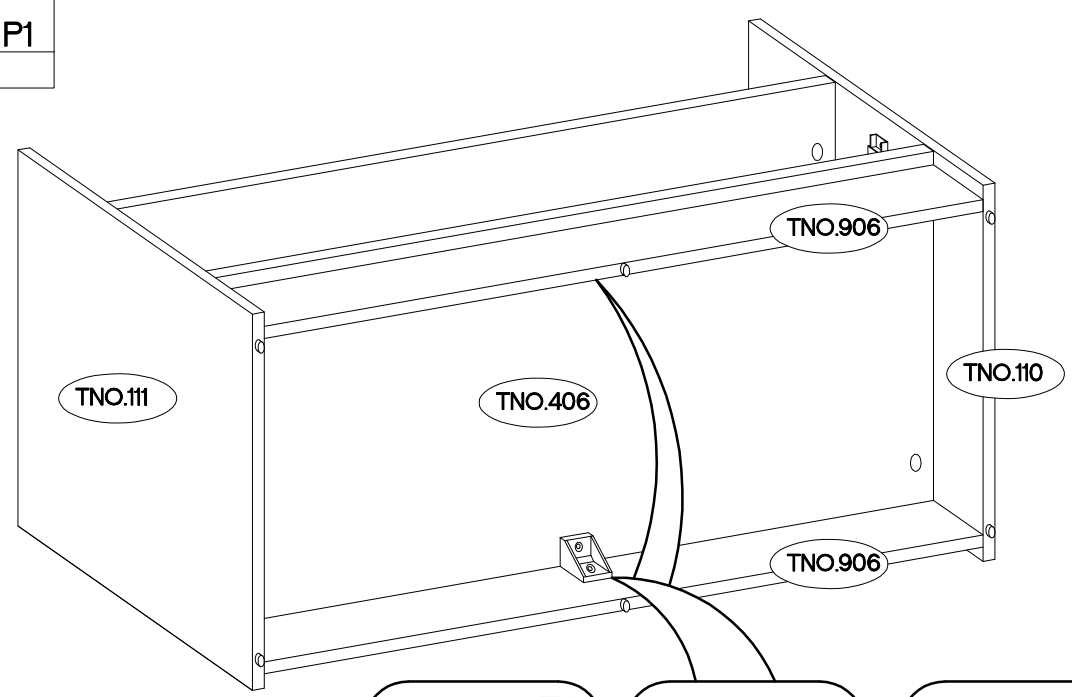
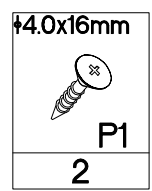



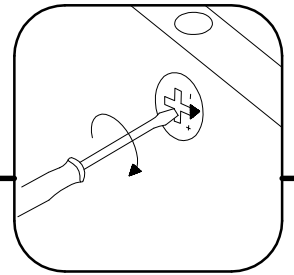
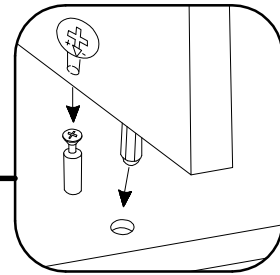
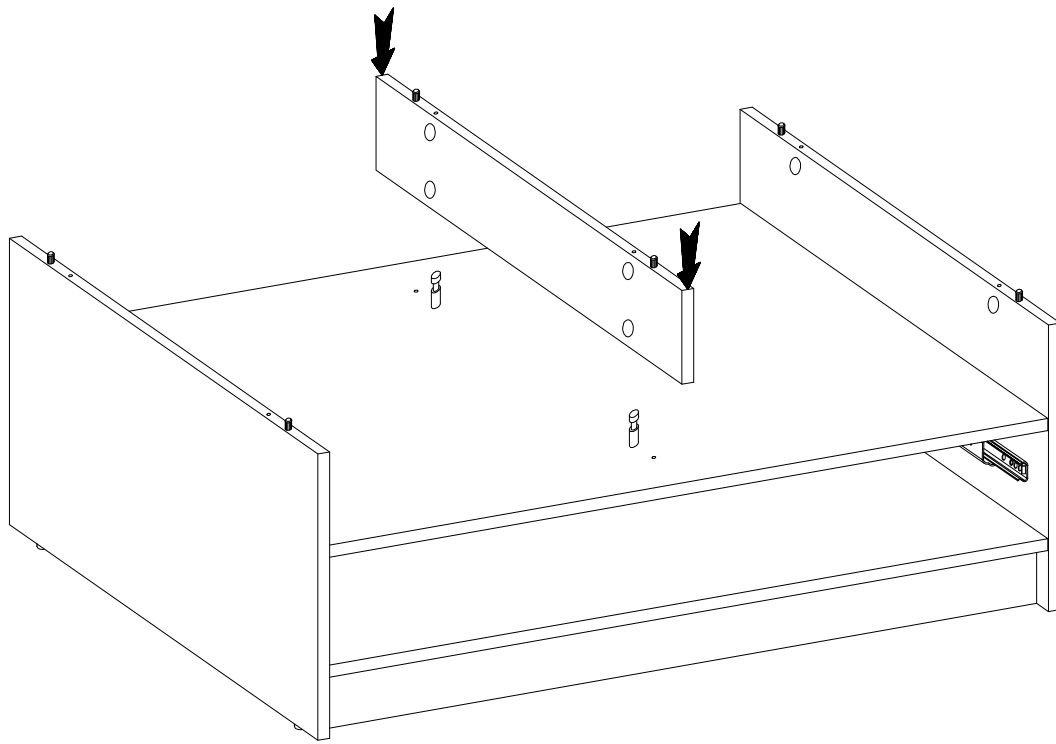

12

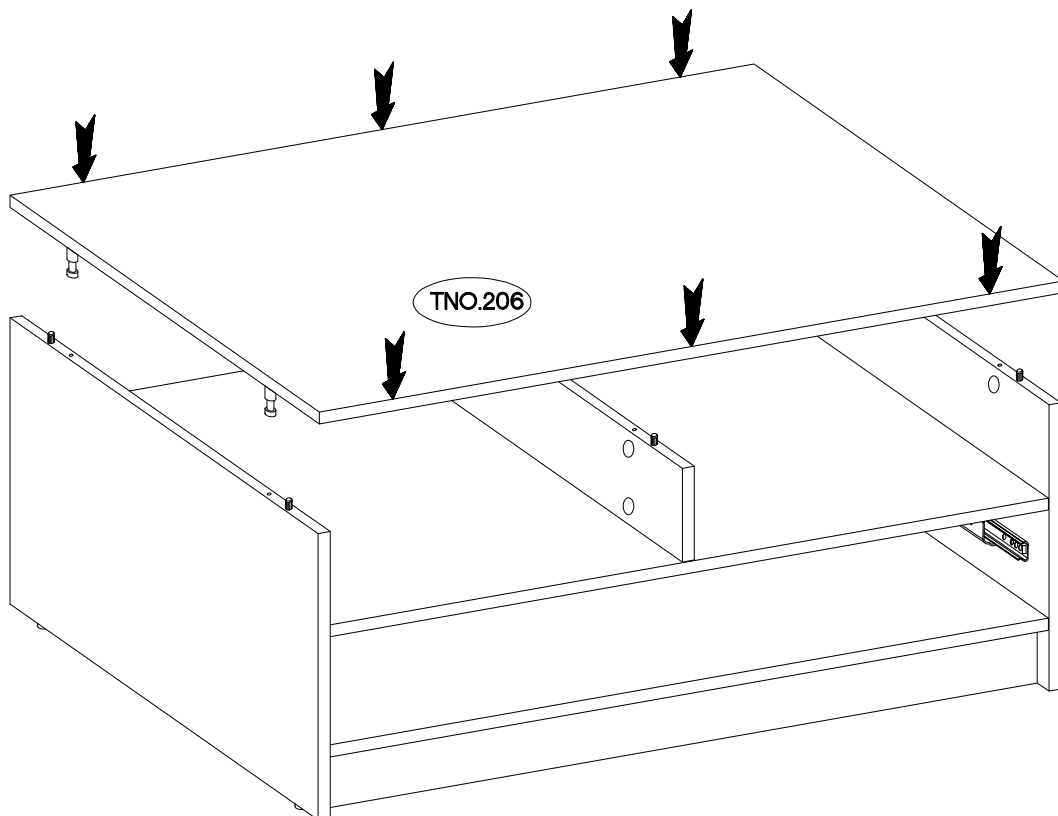

13

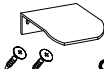

L=32mm	M4x9mm	
		
S	U1	E
1	2	8

